

TBB3

series



Product Segments

• **Comfort Motion**

Capacity	1.8Ah (lithium battery)
Input voltage	24~32V DC
Output voltage	24V DC, 1.8A
Color	black or grey
LED indication (for charge/discharge status)	
Buzzer alarm available	

Drawing

Standard Dimension

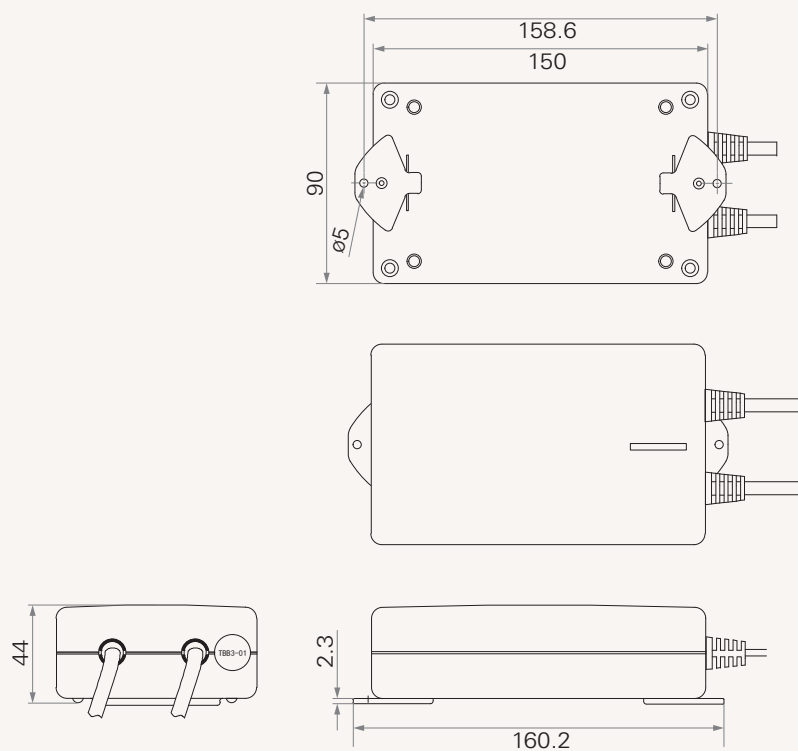

Terms of Use

The user is responsible for determining the suitability of TiMOTION products for a specific application.







Due to continuous development in order to improve our products, TiMOTION products are subject to frequent modifications and changes without prior notice.

TiMOTION reserves the right to discontinue the sale of any products displayed on its website or listed in its catalogue or other written materials drawn up by TiMOTION.

TBB3 Ordering Key

TBB3

Version: 20130510-C

	Color	1 = Black	2 = Grey (Pantone 428C)
	IP Protection	1 = Without	
	Input Plug Type	1 = Small 01 (male plug) 2 = Long DIN 5pin 240° (male plug), plug angle 180°	A = Customized
	Input Cable Length	1 = 100mm (for small 01); 150mm (DIN 5pin) 2 = 1000mm	A = Customized
	Output Plug Type	1 = Small 01 (female plug, with anti pulling clip) 2 = Long DIN 5pin 240° (female plug, with anti pulling clip)	A = Customized
	Output Cable Length	1 = 100mm (for small 01); 150mm (DIN 5pin) 2 = 1000mm	A = Customized
	Buzzer	0 = Without	1 = With (standard)