

TFS2

series



Terms of Use

The user is responsible for determining the suitability of TiMOTION products for a specific application.

Due to continuous development in order to improve our products, TiMOTION products are subject to frequent modifications and changes without prior notice.

TiMOTION reserves the right to discontinue the sale of any products displayed on its website or listed in its catalogue or other written materials drawn up by TiMOTION.

General Features

Maximum available buttons	6
Protection class	IP54 or IP66
Foot switch for medical application	





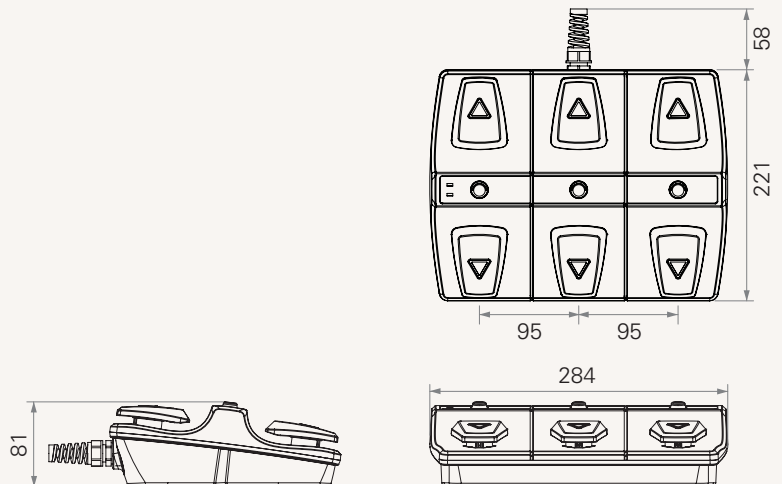

Drawing

Standard Dimension



TFS2

Version: 20130510-B

	Number of Buttons	4 = 4	6 = 6
	Safety Switch	0 = Without	1 = With
	Plug	1 = DIN 5pin, for TDC 2 = DIN 8pin, for TC2/TC3/TC7 4 = DIN 8pin, 180°, for extension cable 5 = RJ 10pin, 180°, for extension cable	6 = RJ 10pin, 90°, for TC1/TC6/TC8/TC9/TC10/TC14 7 = RJ 10pin, 180°, for TC11/TC15/TC16 A = Customized
	Color (Upper & Lower Cover)	1 = Black	2 = Grey (Pantone 428C)
	Color (Buttons)	1 = Black	2 = Grey (Pantone 428C) A = Customized
	IP Protection	1 = Without	2 = IP54 3 = IP66
	Cable	1 = Straight, 1500mm	2 = Straight, 2000mm A = Customized