

# TH12

series



## Product Segments

- **Care Motion**

Connected actuators	1~5
Maximum available buttons	12
Color	black or grey
Protection class	IP54 or IP66
Option	back light, safety key

**Drawing**

Standard Dimension

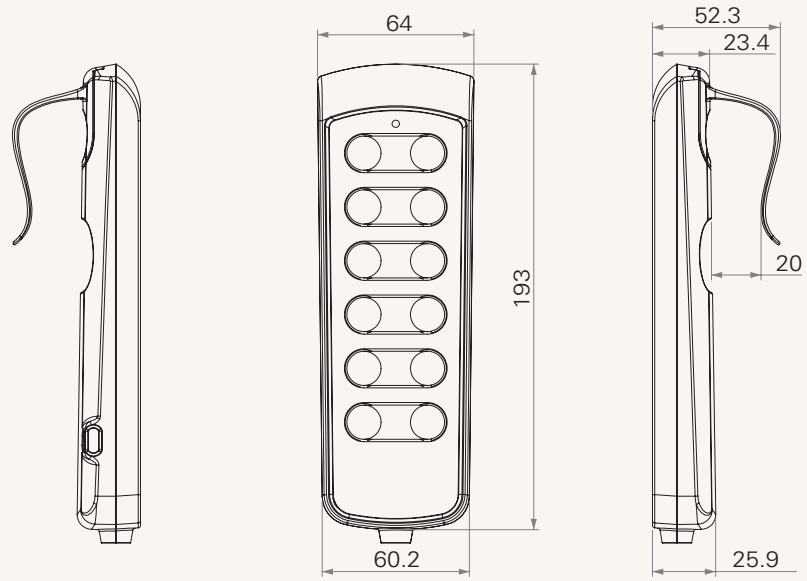

Dimension with Cable Length

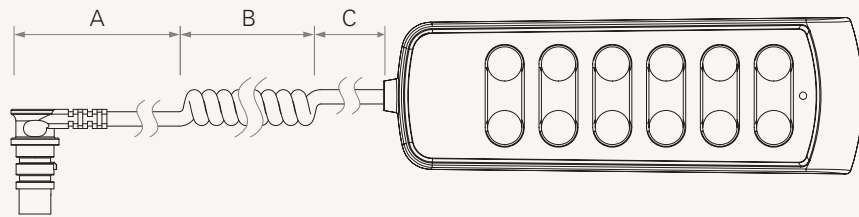

**Cable Length (mm)**

CODE	A	B	C
1	1000	300	200
2	1200	300	300
3	1400	300	400
4	2400	0	0
5	0	600	0
6	1000	200	200
A	Customized length		

**Terms of Use**









The user is responsible for determining the suitability of TiMOTION products for a specific application.

Due to continuous development in order to improve our products, TiMOTION products are subject to frequent modifications and changes without prior notice.

TiMOTION reserves the right to discontinue the sale of any products displayed on its website or listed in its catalogue or other written materials drawn up by TiMOTION.

## TH12

Version: 20130510-E

	<b>Back Light</b>	A = Without	B = With
	<b>Number of Actuators</b>	1 = 1 2 = 2	3 = 3 4 = 4 5 = 5
	<b>Plug</b>	1 = DIN 8pin, for TC2/TC3/TC7 2 = RJ 10pin, 90°, for TC1/TC8/TC10 4 = DIN 8pin, 180°, for extension cable	5 = RJ 10pin, 180°, for TC6/TC9/extension cable A = Customized
	<b>Color</b>	1 = Black	2 = Grey (Pantone 428C)
	<b>IP Protection</b>	1 = Without	2 = IP54 3 = IP66
	<b>Safety Key</b>	0 = Without	1 = With
	<b>Key Definition</b>	A~S = See appendix* Note : please contact TiMOTION before making an order	1 = Customized
	<b>Cable Length</b>	1~6 = See appendix	A = Customized