

# TH17

series



## Product Segments

### • Comfort Motion

Connected actuators	1~4
Maximum available buttons	8
Color	black
Option	safety key, hook
Rubber-made buttons	

## Drawing

Standard Dimension

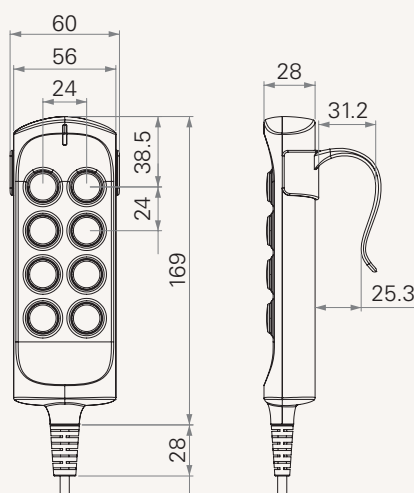

Dimension with Cable Length

Code 1

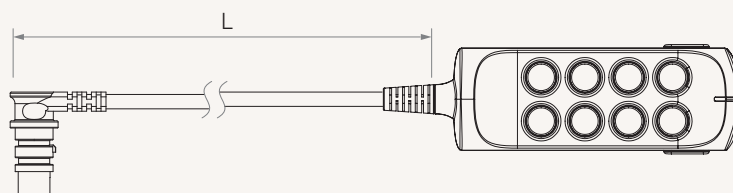

Code 2

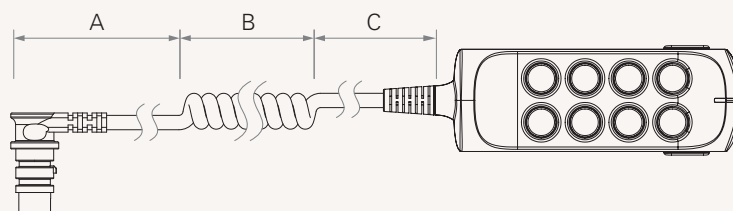

## Cable Length (mm)

### CODE

1	Straight, L=1500
2	Coiled, A=1000, B=200, C=200
A	Customized

## Terms of Use

The user is responsible for determining the suitability of TiMOTION products for a specific application.







Due to continuous development in order to improve our products, TiMOTION products are subject to frequent modifications and changes without prior notice.

TiMOTION reserves the right to discontinue the sale of any products displayed on its website or listed in its catalogue or other written materials drawn up by TiMOTION.

# TH17 Ordering Key

TH17

Version: 20130510-B

	<b>Number of Actuators</b>	1 = 1	2 = 2	3 = 3	4 = 4 (only support tact switch)
	<b>Plug</b>	1 = DIN 5pin, for TDC 2 = DIN 8pin, for TC2/TC3/TC7 3 = Short 5pin DIN, for TDC		4 = DIN 8pin, 180°, for extension cable 5 = RJ 10pin, 180°, for TC6/TC9/extension cable A = Customized	
	<b>Color</b>	1 = Black			
	<b>Safety Key</b>	0 = Without		1 = With	
	<b>Hook</b>	0 = Without		1 = With	
	<b>Key Definition</b>	A~L = See appendix* Note : please contact TiMOTION before making an order		1 = Customized	
	<b>Cable Length</b>	1~2= See appendix		A = Customized	