

TH6

series



Product Segments

• **Comfort Motion**

Connected actuators	1~2
Maximum available buttons	4
Color	black or grey
Screw-free hook	
LED indication	

Drawing

Standard Dimension

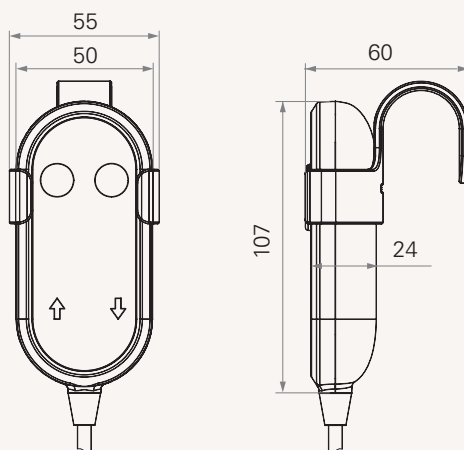

Dimension with Cable Length

Code 1

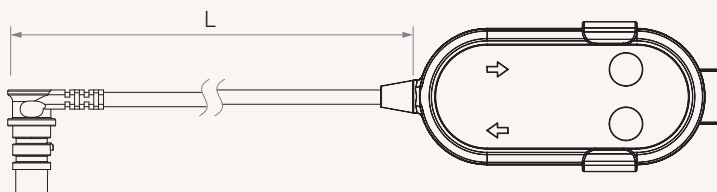

Code 2

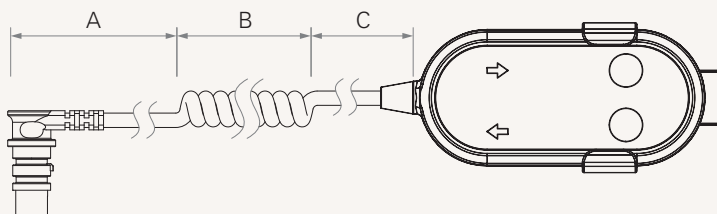

Cable Length (mm)

CODE

1	Straight, L=1500
2	Coiled, A=1000, B=200, C=200
A	Customized

Terms of Use

The user is responsible for determining the suitability of TiMOTION products for a specific application.







Due to continuous development in order to improve our products, TiMOTION products are subject to frequent modifications and changes without prior notice.

TiMOTION reserves the right to discontinue the sale of any products displayed on its website or listed in its catalogue or other written materials drawn up by TiMOTION.

TH6 Ordering Key

TH6

Version: 20130510-F

	Number of Actuators	1 = 1	2 = 2
	Plug	1 = DIN 5pin, for TDC 2 = DIN 8pin, for TC2/TC3/TC7 4 = DIN 8pin, 180°, for extension cable	5 = RJ 10pin, 180°, for TC6/TC9/extension cable A = Customized
	Color	1 = Black	2 = Grey (Pantone 428C)
	Safety Key	0 = Without	1 = With
	Key Definition	A~N = See appendix* Note : please contact TIMOTION before making an order	1 = Customized
	Cable Length	1~2 = See appendix	A = Customized