

TP4

series

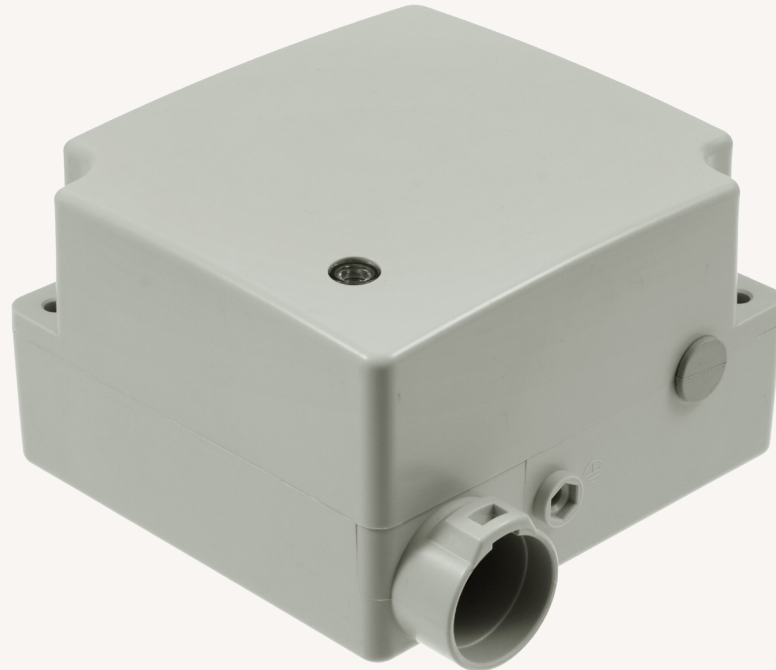

Product Segments

- **Care Motion**

Transformer type	EI, Toroidal, or SMPS
Input voltage	100V AC, 120V AC, 230V AC, or 100~240V AC (SMPS)
Maximum output	29V DC, 5.0A
Plug support	EU, USA, AUS, UK, JPN, or customized
Color	black or grey
Protection class	IP54 or IP66
Certificate	IEC60601-1, ES60601-1, and CB

Drawing

Standard Dimension

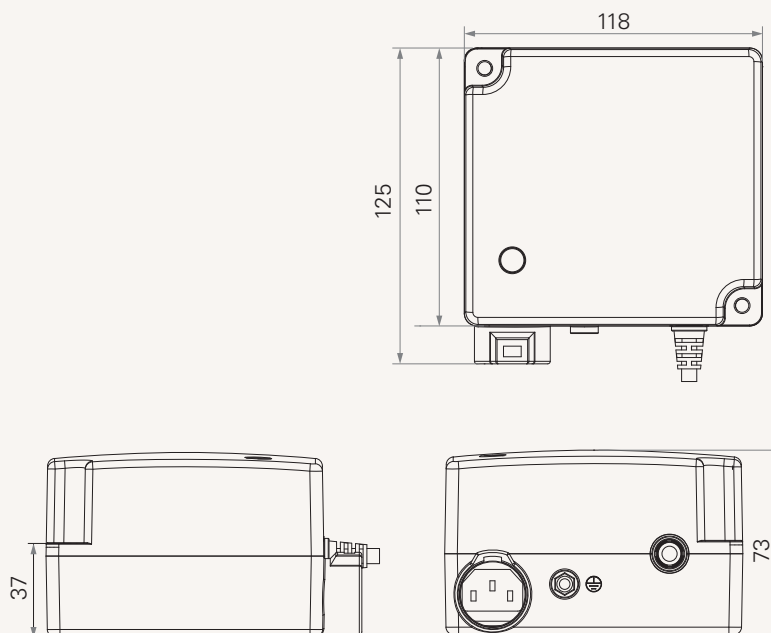

Terms of Use

The user is responsible for determining the suitability of TiMOTION products for a specific application.





Due to continuous development in order to improve our products, TiMOTION products are subject to frequent modifications and changes without prior notice.

TiMOTION reserves the right to discontinue the sale of any products displayed on its website or listed in its catalogue or other written materials drawn up by TiMOTION.

TP4 Ordering Key

TP4

Version: 20130510-D

	Voltage	1 = 110V AC	2 = 120V AC	3 = 230V AC	4 = 100~240V AC (SMPS)
	Plug	1 = EU 2 = USA	3 = AUS 4 = UK	5 = JPN A = Others	
	Color	1 = Black		2 = Grey (Pantone 428C)	
	Cable Length	0 = AC cable: straight, 4000mm; DC cable: straight, 150mm (mount on TC8) 1 = AC cable: straight, 2000mm; DC cable: straight, 1000mm 2 = AC cable: straight, 4000mm; DC cable: straight, 1000mm			A = Customized
	Grounding Function	0 = Without		1 = With	